

INSTRUCTION MANUAL

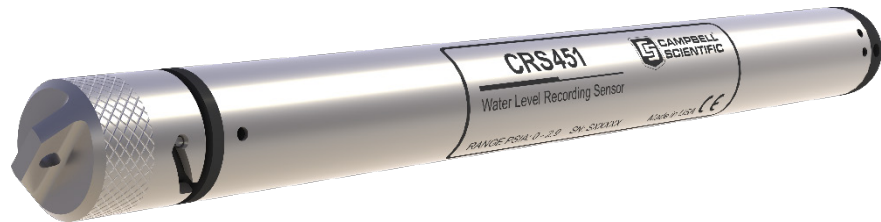

CRS451/CRS456 Submersible Water-Level Recording Sensor

Revision: 8/15



Limited Warranty

“Products manufactured by CSI are warranted by CSI to be free from defects in materials and workmanship under normal use and service for twelve months from the date of shipment unless otherwise specified in the corresponding product manual. (Product manuals are available for review online at www.campbellsci.com.) Products not manufactured by CSI, but that are resold by CSI, are warranted only to the limits extended by the original manufacturer. Batteries, fine-wire thermocouples, desiccant, and other consumables have no warranty. CSI’s obligation under this warranty is limited to repairing or replacing (at CSI’s option) defective Products, which shall be the sole and exclusive remedy under this warranty. The Customer assumes all costs of removing, reinstalling, and shipping defective Products to CSI. CSI will return such Products by surface carrier prepaid within the continental United States of America. To all other locations, CSI will return such Products best way CIP (port of entry) per Incoterms ® 2010. This warranty shall not apply to any Products which have been subjected to modification, misuse, neglect, improper service, accidents of nature, or shipping damage. This warranty is in lieu of all other warranties, expressed or implied. The warranty for installation services performed by CSI such as programming to customer specifications, electrical connections to Products manufactured by CSI, and Product specific training, is part of CSI’s product warranty. **CSI EXPRESSLY DISCLAIMS AND EXCLUDES ANY IMPLIED WARRANTIES OF MERCHANTABILITY OR FITNESS FOR A PARTICULAR PURPOSE. CSI hereby disclaims, to the fullest extent allowed by applicable law, any and all warranties and conditions with respect to the Products, whether express, implied or statutory, other than those expressly provided herein.”**

Assistance

Products may not be returned without prior authorization. The following contact information is for US and international customers residing in countries served by Campbell Scientific, Inc. directly. Affiliate companies handle repairs for customers within their territories. Please visit www.campbellsci.com to determine which Campbell Scientific company serves your country.

To obtain a Returned Materials Authorization (RMA), contact CAMPBELL SCIENTIFIC, INC., phone (435) 227-9000. After an application engineer determines the nature of the problem, an RMA number will be issued. Please write this number clearly on the outside of the shipping container. Campbell Scientific's shipping address is:

CAMPBELL SCIENTIFIC, INC.

RMA# _____
815 West 1800 North
Logan, Utah 84321-1784

For all returns, the customer must fill out a "Statement of Product Cleanliness and Decontamination" form and comply with the requirements specified in it. The form is available from our web site at www.campbellsci.com/repair. A completed form must be either emailed to repair@campbellsci.com or faxed to (435) 227-9106. Campbell Scientific is unable to process any returns until we receive this form. If the form is not received within three days of product receipt or is incomplete, the product will be returned to the customer at the customer's expense. Campbell Scientific reserves the right to refuse service on products that were exposed to contaminants that may cause health or safety concerns for our employees.

Precautions

DANGER — MANY HAZARDS ARE ASSOCIATED WITH INSTALLING, USING, MAINTAINING, AND WORKING ON OR AROUND TRIPODS, TOWERS, AND ANY ATTACHMENTS TO TRIPODS AND TOWERS SUCH AS SENSORS, CROSSARMS, ENCLOSURES, ANTENNAS, ETC. FAILURE TO PROPERLY AND COMPLETELY ASSEMBLE, INSTALL, OPERATE, USE, AND MAINTAIN TRIPODS, TOWERS, AND ATTACHMENTS, AND FAILURE TO HEED WARNINGS, INCREASES THE RISK OF DEATH, ACCIDENT, SERIOUS INJURY, PROPERTY DAMAGE, AND PRODUCT FAILURE. TAKE ALL REASONABLE PRECAUTIONS TO AVOID THESE HAZARDS. CHECK WITH YOUR ORGANIZATION'S SAFETY COORDINATOR (OR POLICY) FOR PROCEDURES AND REQUIRED PROTECTIVE EQUIPMENT PRIOR TO PERFORMING ANY WORK.

Use tripods, towers, and attachments to tripods and towers only for purposes for which they are designed. Do not exceed design limits. Be familiar and comply with all instructions provided in product manuals. Manuals are available at www.campbellsci.com or by telephoning (435) 227-9000 (USA). You are responsible for conformance with governing codes and regulations, including safety regulations, and the integrity and location of structures or land to which towers, tripods, and any attachments are attached. Installation sites should be evaluated and approved by a qualified engineer. If questions or concerns arise regarding installation, use, or maintenance of tripods, towers, attachments, or electrical connections, consult with a licensed and qualified engineer or electrician.

General

- Prior to performing site or installation work, obtain required approvals and permits. Comply with all governing structure-height regulations, such as those of the FAA in the USA.
- Use only qualified personnel for installation, use, and maintenance of tripods and towers, and any attachments to tripods and towers. The use of licensed and qualified contractors is highly recommended.
- Read all applicable instructions carefully and understand procedures thoroughly before beginning work.
- Wear a **hardhat** and **eye protection**, and take **other appropriate safety precautions** while working on or around tripods and towers.
- **Do not climb** tripods or towers at any time, and prohibit climbing by other persons. Take reasonable precautions to secure tripod and tower sites from trespassers.
- Use only manufacturer recommended parts, materials, and tools.

Utility and Electrical

- **You can be killed** or sustain serious bodily injury if the tripod, tower, or attachments you are installing, constructing, using, or maintaining, or a tool, stake, or anchor, come in **contact with overhead or underground utility lines**.
- Maintain a distance of at least one-and-one-half times structure height, 20 feet, or the distance required by applicable law, **whichever is greater**, between overhead utility lines and the structure (tripod, tower, attachments, or tools).
- Prior to performing site or installation work, inform all utility companies and have all underground utilities marked.
- Comply with all electrical codes. Electrical equipment and related grounding devices should be installed by a licensed and qualified electrician.

Elevated Work and Weather

- Exercise extreme caution when performing elevated work.
- Use appropriate equipment and safety practices.
- During installation and maintenance, keep tower and tripod sites clear of un-trained or non-essential personnel. Take precautions to prevent elevated tools and objects from dropping.
- Do not perform any work in inclement weather, including wind, rain, snow, lightning, etc.

Maintenance

- Periodically (at least yearly) check for wear and damage, including corrosion, stress cracks, frayed cables, loose cable clamps, cable tightness, etc. and take necessary corrective actions.
- Periodically (at least yearly) check electrical ground connections.

WHILE EVERY ATTEMPT IS MADE TO EMBODY THE HIGHEST DEGREE OF SAFETY IN ALL CAMPBELL SCIENTIFIC PRODUCTS, THE CUSTOMER ASSUMES ALL RISK FROM ANY INJURY RESULTING FROM IMPROPER INSTALLATION, USE, OR MAINTENANCE OF TRIPODS, TOWERS, OR ATTACHMENTS TO TRIPODS AND TOWERS SUCH AS SENSORS, CROSSARMS, ENCLOSURES, ANTENNAS, ETC.

Table of Contents

PDF viewers: These page numbers refer to the printed version of this document. Use the PDF reader bookmarks tab for links to specific sections.

1. Introduction	1
2. Cautionary Statements	1
3. Initial Inspection and Handling Guidelines	1
3.1 Ships With	2
4. Overview	2
5. Specifications	2
6. Installation	4
6.1 Appropriate Depth	4
6.2 Avoiding Freezing Conditions	5
6.3 Dislodge Bubbles	5
6.4 Well Installation	5
6.5 Other Installations	6
6.6 Battery Voltage Reading	6
6.7 Attaching Suspension Cable to CRS451/CRS456	6
6.8 Heyco Cable Grip	8
7. Programming	9
7.1 Settings	9
7.2 Connect to the CRS451/CR456	9
7.3 Configure CRS45X for Measurements	11
7.4 Compensating Measurements for Barometric Pressure	17
7.4.1 Using an Additional CRS45X	17
7.4.2 Using a Barometer	17
8. Maintenance	22
8.1 Every Visit	22
8.2 Every Two to Three Years or on a Rotating Schedule	22
8.3 Battery Replacement	23
9. Troubleshooting	28
Appendices	
A. Calibration Certificate	A-1
B. Conversion to Units of Measurement	B-1

Figures

6-1. 31648 Heyco Cable Grip..... 8
6-2. Transducer mounted in PVC pipe using the 31648 Heyco cable
grip..... 8

Table

B-1. Conversion Factors..... B-1

CRS451/CRS456 Submersible Water-Level Recording Sensor

1. Introduction

The CRS451 consists of a water-level and water-temperature sensor that has its own time clock and memory to store the collected data, in a compact stainless-steel case. This frees users to place the sensor in remote sites and let it collect data for long periods of time. The CRS451/CRS456 supports standard time-based scanning and recording along with event-based recording based on water level change (Delta) or logarithmic time sequence for pump and slug tests. *HydroSci* software is included and supports test set up, data retrieval, and data display.

The CRS451 has a 316L stainless-steel case that can be submerged in most canals, wells, ponds, lakes, and streams. The CRS456 has a rugged titanium case that allows it to be used in saltwater or other harsh environments.

Before using the CRS451/CRS456, please study:

- Section 2, *Cautionary Statements* (p. 1)
- Section 3, *Initial Inspection and Handling Guidelines* (p. 1)
- Section 6, *Installation* (p. 4)

2. Cautionary Statements

- The CRS451/CRS456 will be damaged if encased in frozen liquid (see Section 6.2, *Avoiding Freezing Conditions* (p. 5), for more information).
- Although the CRS451/CRS456 is a rugged and reliable device, it is also a highly precise scientific instrument and should be handled as such.
- Dropping the instrument or allowing it to “free fall” down a well may damage the transducer.
- Confirm the compatibility of the instrument to non-water environments before installation.
- The CRS456 should be used in harsh water applications, including salt water.

3. Initial Inspection and Handling Guidelines

- Upon receipt of the CRS451/CRS456, inspect the packaging for any signs of shipping damage. File damage claims with the shipping company.
- Immediately check package contents against the shipping documentation (see Section 3.1, *Ships With* (p. 2)). Contact Campbell Scientific with any discrepancies.

- The model number and pressure range are etched on the housing. Check this information against the shipping documentation to ensure that the expected product was received.

3.1 Ships With

- 27555 USB 2.0 Cable Type A Male to Micro B Male, 6ft
- 29225 *HydroSci* Software on CD

4. Overview

The CRS451/CRS456, *Submersible Water-Level Recording Sensor*, provides reliable, accurate pressure/level measurements that are fully temperature compensated.

The 24 bit A/D has simultaneous 50/60 Hz rejection and automatic calibration for each measurement. A number of additional advanced measurement techniques are employed to harness the best possible performance available from today's state of the art pressure sensor technology. The CRS451/CRS456 reverts to a low power sleep state between measurements. A series of measurements are performed yielding a temperature and pressure value. This measurement cycle can be as fast as 1 second.

The design features a piezoresistive sensor housed in a 316L stainless steel (CRS451) or titanium (CRS456) package to enhance reliability. The rugged construction makes the CRS451/CRS456 suitable for water level measurement in irrigation applications, water wells, lakes, streams, and tanks. The titanium package of the CRS456 makes it ideal for salt water or other harsh environments.

The CRS451/CRS456 has three nose cone options. The weighted nose cone makes the transducer easier to submerge to depth. The NPT option allows the sensor to be mounted to a 1/4 inch fitting. The nose cones can be exchanged at a later time.

Communicating with the CRS451/CRS456 requires a micro USB cable and *HydroSci* software running on a computer with Windows XP or later. Configurable settings can be changed using Campbell Scientific's *HydroSci* software utility.

5. Specifications

Features:

- Field replaceable batteries
- Campbell Scientific quality
- No additional datalogger, enclosure, and power supply; reduces system costs and simplifies installation
- Free customer-friendly software for communication, configuration, data collection

- Fast scan rate
- Large data storage capacity
- High accuracy
- Long battery life
- Data retrieval through sealed USB connector

Measurement Time: < 1 s typical

Output: micro USB

Internal Data

Collection Memory: 4 MB

HydroSci Supported

Operating Systems: Windows XP, Windows Vista, or Windows 7

Logging/Scanning Modes: Standard, Delta, Logarithmic

Power Requirements: Internal user-replaceable lithium battery

Battery Life: 5+ years when logging interval is once per hour

Power Consumption

Quiescent Current: < 80 μ A

Measurement/

Communication Current: 4 mA for 1 s measurement

Measurement Ranges¹:

Pressure (psig)	Pressure (kPa)	Meters of fresh water	Feet of fresh water
0 to 7.25	0 to 50	0 to 5.1	0 to 16.7
0 to 14.5	0 to 100	0 to 10.2	0 to 33.4
0 to 29	0 to 200	0 to 20.4	0 to 67
0 to 72.5	0 to 500	0 to 50.9	0 to 167
0 to 145	0 to 1000	0 to 102	0 to 334.5

Accuracy

Pressure Reading²: 0.1% full-scale range TEB³

Temperature: ± 0.2 °C

Resolution: 0.0035% full-scale range

Overpressure: 2x pressure range

Dry Storage Temperature: -30 to 80 °C

Operating Temperature: 0 to 60 °C

CAUTION Freezing conditions may damage the CRS451/CRS456 (see Section 6.2, *Avoiding Freezing Conditions* (p. 5), for more information).

Body Material

CRS451: 316L Stainless Steel
CRS456: Titanium

Element Material

CRS451: 316L Stainless Steel
CRS456: Hastelloy®

Standard Cone Material: Delrin®

Weighted and NPT Material: Stainless Steel

Dimensions

Length: 22.23 cm (8.75 in)
Diameter: 2.22 cm (0.875 in)

Weight: 230 g (0.51 lb)

¹The CRS451 is a sealed gage sensor and when not submerged will read approximately 1 bar at sea level and less as elevation increases. The CRS451 is calibrated at 9 pressures starting at 0.6 bar up to full scale referenced to 1 bar. Points below 1 bar are used in the calibration for the benefit of those who deploy this sensor at elevations above sea level.

²The accuracy specification listed pertains to the level of accuracy that the CRS451/CRS456 is able to measure pressure. If a barometric pressure sensor is used to remove the component of atmospheric pressure from the pressure reading provided by the CRS451/CRS456 while submerged in a column of water vented to the atmosphere, the error of the barometric sensor must be considered when calculating the resulting accuracy of the water level reading.

³Total Error Band (TEB) includes the combined errors due to nonlinearity, hysteresis, nonrepeatability, and thermal effects over the compensated temperature range, per ISA S51.1.

6. Installation

The CRS451/CRS456 is designed for water level measurements. Typical applications include agricultural water level/flow, water wells, lakes, streams, and tanks. If the device is to be installed in a liquid other than water or in contaminated water, check the compatibility of the wetted material. The CRS456 should be used in harsh water applications, including salt water.

6.1 Appropriate Depth

The CRS451/CRS456 must be installed below the water at a fixed depth. This depth should be chosen so that the water pressure will never exceed the transducer's pressure range (twice its pressure rating).

CAUTION The output reading will not be correct, and the transducer can be damaged if pressure is twice its pressure rating.

Pressure can be converted to feet of fresh water using the following simple equation:

$$1 \text{ psi} = 2.31 \text{ feet of water}$$

For example, the maximum depth with a pressure range of 0 to 7.25 psig is 16.748 feet of water.

6.2 Avoiding Freezing Conditions

Expansion of water due to freezing will irreparably damage the CRS451/CRS456. The CRS451/CRS456 can be safely deployed in freezing conditions if the sensor is placed below the frost line. In a lake or channel of moving water, often the sensor can be placed deep enough to avoid freezing. In shallow conditions, where the water body is at risk of freezing solid, placing the sensor in a stilling well that extends below the frost line will protect the sensor from freezing water.

6.3 Dislodge Bubbles

While submersing the CSR451/CRS456, air bubbles may become trapped inside the nose cone, causing small, offset errors until the bubbles dissolve. Dislodge these bubbles by gently shaking the CRS451/CRS456 while under water.

CAUTION Hitting the instrument against the well casing or other solid surface could damage the CRS451/CRS456.

CAUTION If the bubbles are not removed by rotation and shaking underwater (or bleeding out the air in a closed system), the CRS451/CRS456 reading will drift lower by the distance of the gap as the air is slowly dissolved into the water over time.

6.4 Well Installation

Braided stainless steel cable (pn 29221-L) is used to lower the instrument to an appropriate depth and to suspend the CRS451/CRS456 in a well.

With long drops, it may be necessary to use the weighted nose cone (option –WN).

For surface installations the instrument's body can be strapped with tie wraps or tape. Campbell Scientific offers cable ties (pn 7421) to secure the cable. If installing in a well, fasten the cable to the well head.

6.5 Other Installations

The CRS451/CRS456 can be installed in any position; however, when it leaves the factory it is tested in the vertical position. There will be an offset error if not installed vertically; contact Campbell Scientific for more information. Strapping the transducer body with tie wraps or tape will not hurt it.

6.6 Battery Voltage Reading

The voltage of the lithium ion battery used in the CRS451/CRS456 will abruptly decrease at the end of the battery's useful life, which makes predicting remaining battery life difficult by measuring battery voltage alone. Knowing the energy consumption of the CRS451/CRS456 while in operation, *HydroSci* displays a predicted remaining battery life by combining an estimate of the energy consumed based on the totalized measurements since new and direct battery measurements. For this reason, if the battery is removed from the CRS451/CRS456 anytime during deployment and then replaced, *HydroSci* will assume a fresh battery was added to the device and the estimated remaining battery life will be overstated.

For similar reasons, if the operating system is upgraded or sent to the CRS451/CRS456, the estimated remaining battery life will also be exaggerated by *HydroSci*.

6.7 Attaching Suspension Cable to CRS451/CRS456

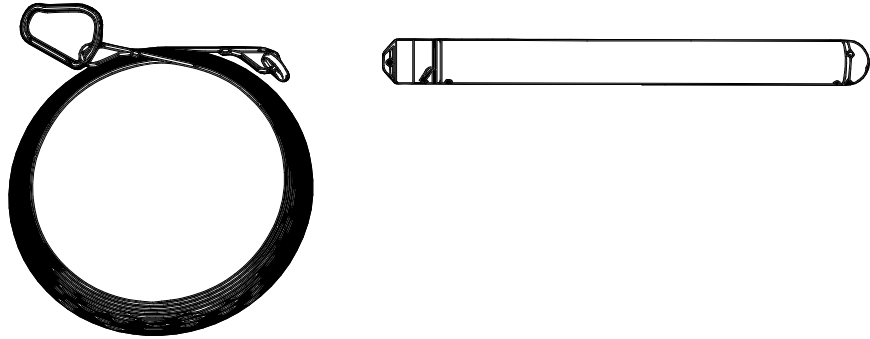

Attach the split ring to the CRS451 cap.

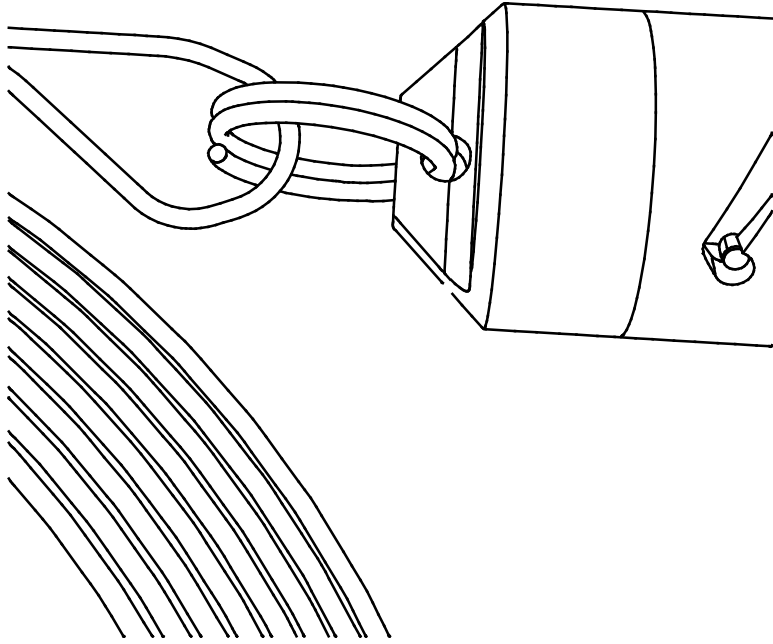

6.8 Heyco Cable Grip

To protect your transducer during deployment, Campbell Scientific offers the 31648 Heyco cable grip (FIGURE 6-1) to clamp the transducer to the submerged end of a 1-inch PVC pipe (FIGURE 6-2). The PVC pipe will help protect the sensor and cable from debris and disturbances while also providing a more secure means of anchoring the sensor to minimize movement. The 31648 Heyco fitting is not meant to be water tight and water will likely fill the submerged pipe behind the fitting. A 1-inch female adapter socket with FPT threads is needed between the 31648 and 1-inch PVC pipe. This adapter socket is available at any store that sells PVC pipe.



FIGURE 6-1. 31648 Heyco Cable Grip

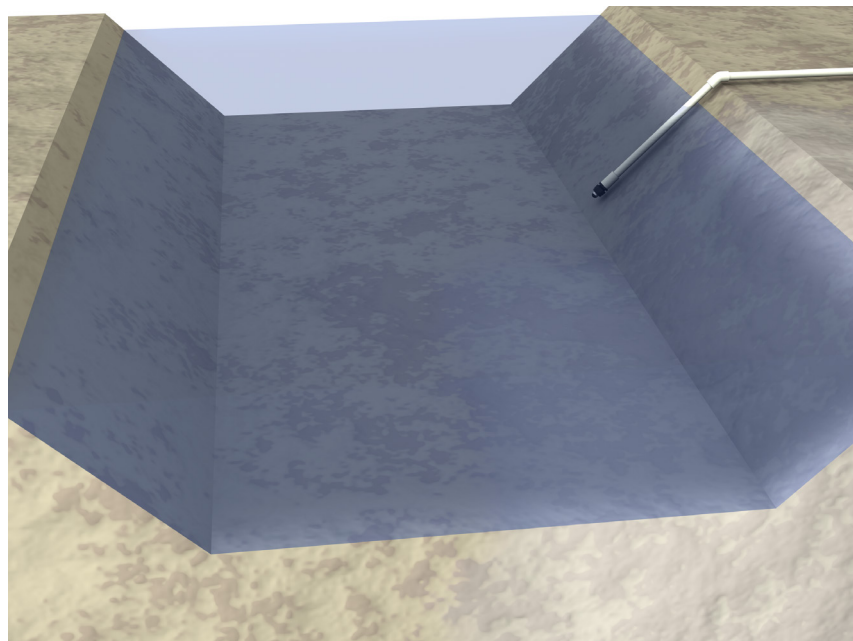

FIGURE 6-2. Transducer mounted in PVC pipe using the 31648 Heyco cable grip

7. Programming

Communicating with the CRS451/CRS456 requires a micro USB cable and *HydroSci* software running on a computer with Windows XP or later.

The CRS451/CRS456 is configured using the *HydroSci* software provided with the unit. A DVD containing *HydroSci* is shipped with the CRS451/CRS456.

CAUTION

If you are using an XP computer, please have the driver disc in the CD/DVD drive before plugging in the USB cord. A driver will need to be installed before the computer can connect with the sensor.

7.1 Settings

Before connecting to the CRS451/CR456, you can change the sensor name or the appearance of *HydroSci* screens by clicking on Settings at the upper right portion of the *HydroSci* screen.

7.2 Connect to the CRS451/CR456

1. Select **CRS45X** from the left margin.
2. Select appropriate **COM Port**.
3. If you have not made a USB connection to your computer, click on the **Show Connect Instructions and Device Installation** drop-down arrow.



4. After clicking the drop-down arrow, you get the following instructions:

CRS45X

 **Hide Connect Instructions and Device Driver Installation...**

In order to connect to the CRS45X, you must connect the USB connection to your computer. Then you must select the corresponding USB serial port that was discovered for that particular CRS45X.

CRS451 or CRS456:
Before connecting, if you have not done so already, please install the device driver with this link: [Install Device Driver](#)

CRS451V or CRS456V:
The CRS451V and CRS456V require one of the following interfaces to connect to a PC:

- A200 Sensor to PC Interface
- PN 28838, ten-position terminal to DB9 terminal block

The A200 USB driver should be installed automatically when you plug the port into your computer, provided there is a working internet connection. If not, the driver can be installed from the Resource DVD or from <http://www.campbellsci.com/a200-support>

5. After making a USB connection to your computer, click the **Connect** button.

7.3 Configure CRS45X for Measurements

1. Click **Configuration**.
2. Select **Create New Configuration** button located at lower left of screen.

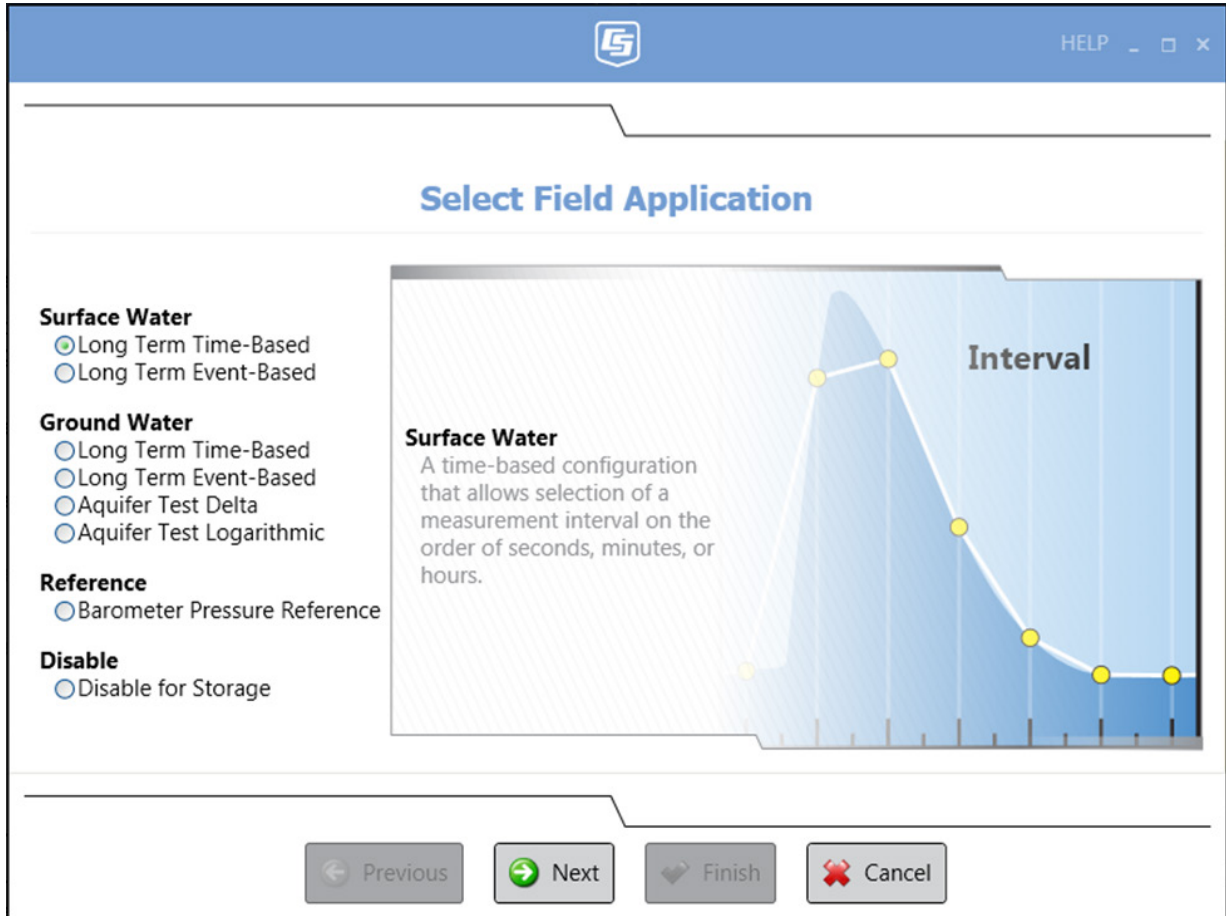

3. Select the type of measurements you want to make.
 - a) Barometer Pressure Reference should be selected if you want to use CR45X sensor as a barometer to compensate for changes in barometric pressure.

NOTE

See Section 7.4.2, *Using a Barometer* (p. 17), if using the measurements from a nearby barometer to correct for the barometric pressure.

- b) Disable: To preserve battery between deployments always configure the sensor for storage after use.

4. Add offset to relate water level measurements to a known datum or reference point. (Aquifer test start at level 0.)
 - a) This step is optional and not required.
 - b) This offset takes effect at the Start Time—which is set in a subsequent screen—so it is necessary that this sensor be in its permanent measurement position before the Start Time, otherwise the offset correction will not be correct.

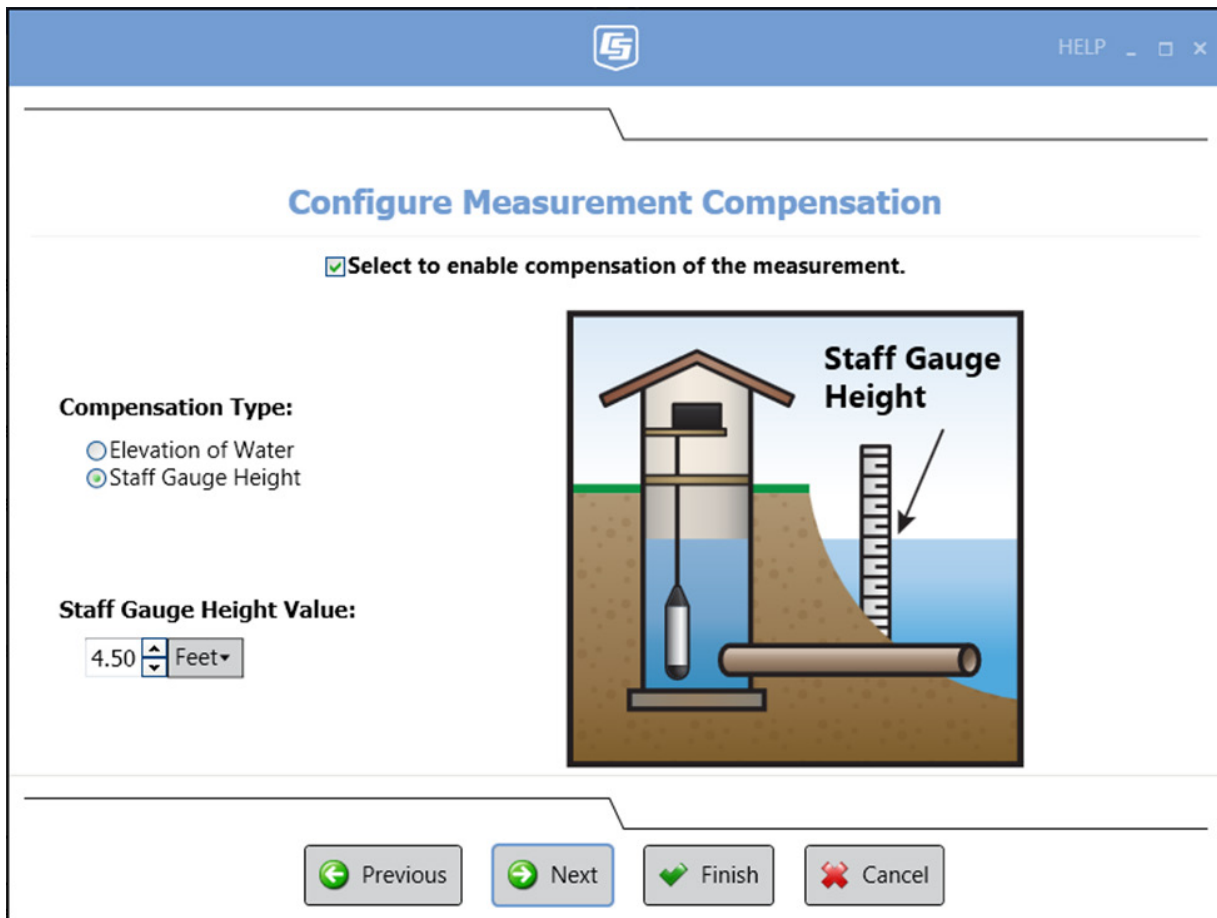

5. Select a **Start and Stop Time**.
 - a) Select a time in the future when measurements should begin. Selecting a time in the past will force the sensor to begin making measurements immediately at the indicated frequency. If an offset calculation was selected in the previous screen, the sensor will not make correct measurements. If an offset calculation is needed, a Start Time must be selected far enough in the future that the sensor can be properly placed in its measurement position before measurements begin.

b) If desired, select time in future when measurements should cease.

The screenshot shows a web browser window with a blue header bar containing a logo and a 'HELP' link. The main content area is titled 'Configure Measurement Timing'. It features two checked checkboxes: 'Start Time' and 'End Time'. The 'Start Time' is set to 'Friday, May 03, 2013 1:55:27 PM' and the 'End Time' is set to 'Thursday, May 16, 2013 1:55:27 PM'. Below these, there is a field 'Make a measurement every' with a value of '10' and a dropdown menu set to 'Second(s)'. At the bottom of the window, there are four buttons: 'Previous' (with a left arrow), 'Next' (with a right arrow), 'Finish' (with a downward arrow), and 'Cancel' (with a red X).

c) Select the rate at which measurements will be made. This does not configure the sensor for data storage, only the rate at which measurements are made.

6. **Select and Name Data Tables for Datalogging.**

- a) Up to four different Data Tables can archive data at independent intervals with any combination of elements (samples, averages, maximum, etc).
- b) Contents of the **Data Table** are selected in the next screen.

Output Table(s)	Table Interval
<input checked="" type="checkbox"/> Table1	15 Minute(s)
<input checked="" type="checkbox"/> Table2	1035 Minute(s)
<input type="checkbox"/> Table3	0 Minute(s)
<input type="checkbox"/> Table4	0 Minute(s)

Navigation buttons: Previous, Next, Finish, Cancel

7. Select which data, in which format and unit of measurement, is to be included in each of the data tables selected in the previous screen.

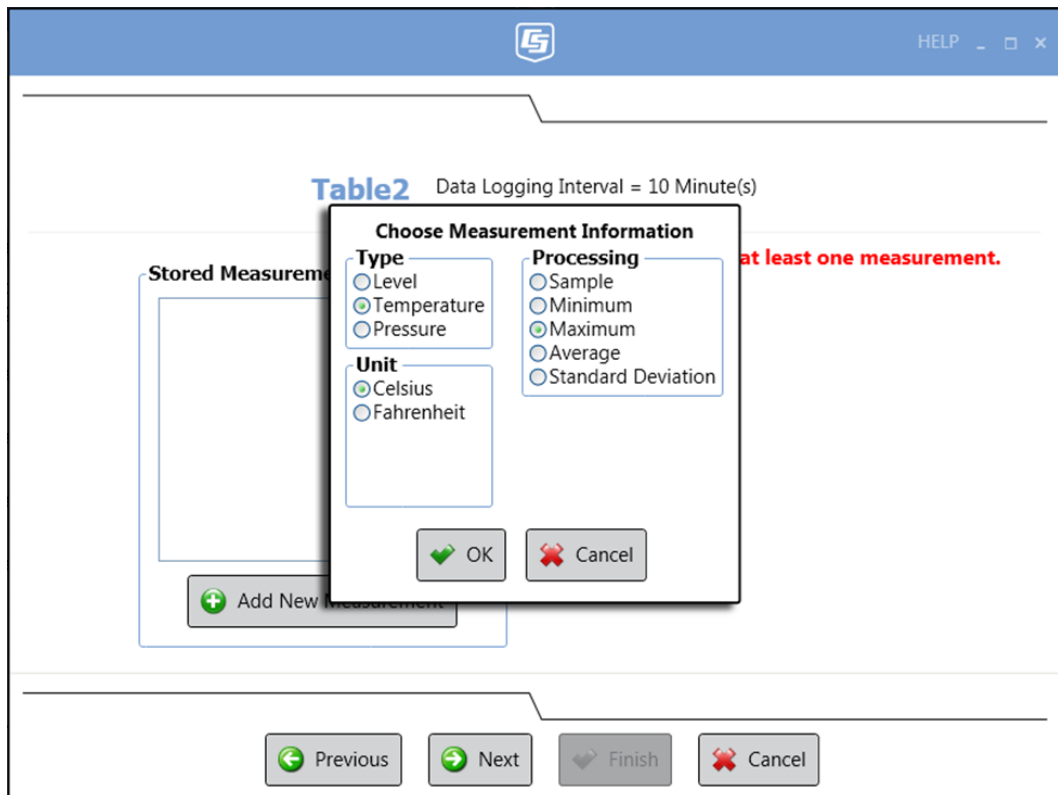
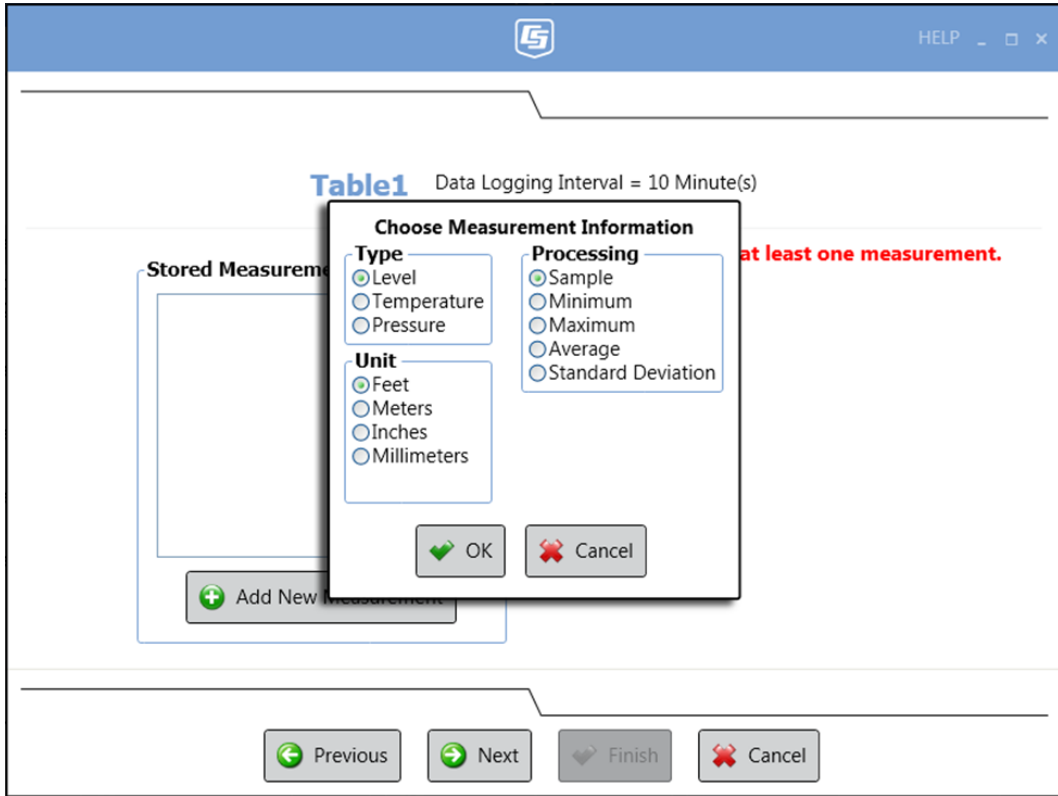

8. Once the **Data Tables** have been configured, the configuration process is finished and the **Finish** button can be selected.
9. Once the configuration is complete, it must be copied to the CRS451 before it will take effect. Click on **Apply Configuration to CRS45X** to start this process.

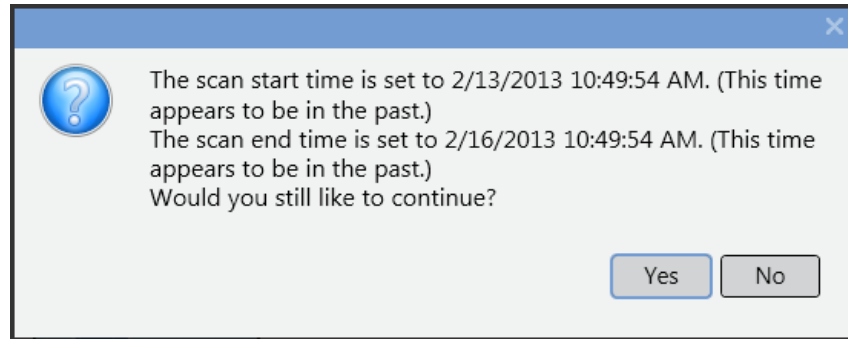

Before sending the configuration file to the CRS45X, *HydroSci* may provide a warning that your start and stop times may need adjusting. If the Start Time is in the past, the CRS45X will immediately begin logging data but any offset you may have applied will not be effective. Also, if the Stop Time is in the past, no data will be logged.

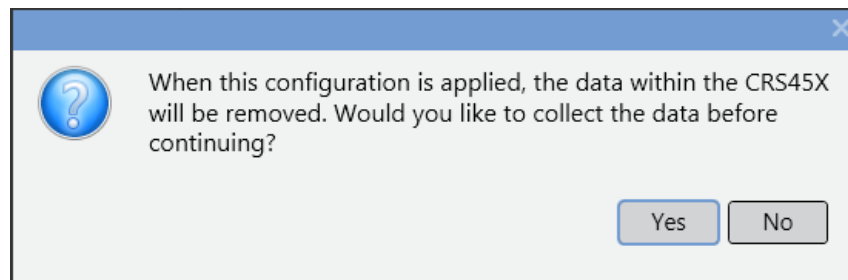

Save data if you have not already done so. Archived data is purged from the CRS45X when a new configuration file is copied so you will want to collect any data before sending the configuration file.

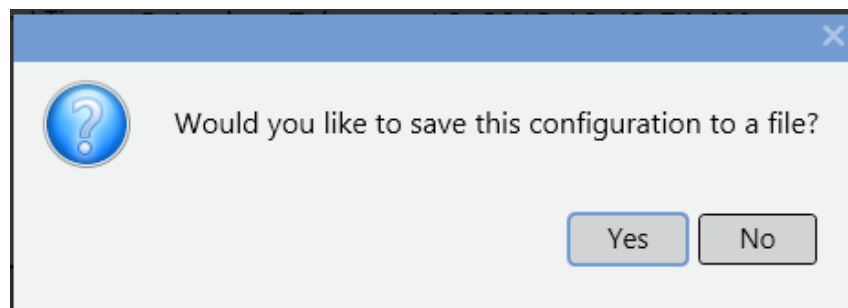

This option allows you to save the configuration file for future reference or for easy use in other similarly deployed sensors.

The CRS451 is calibrated to pressure units in psi. TABLE B-1, *Conversion Factors (p. B-1)*, contains the conversion factors used to convert psi to depth of water.

7.4 Compensating Measurements for Barometric Pressure

The CRS45X pressure transducer is unvented; therefore it is monitoring sealed gage pressure and should be corrected for barometric pressure.

7.4.1 Using an Additional CRS45X

One simple way to complete this correction is to deploy an additional CRS45X as a reference sensor. For this method, in the Select Field Application window, choose Barometer Pressure Reference (see Section 7.3, *Configure CRS45X for Measurements (p. 11)*).

7.4.2 Using a Barometer

The barometric pressure data from a nearby Campbell Scientific weather station or other Campbell Scientific monitoring platform can also be used to compensate for barometric pressure. The **Data** tab is used to process and merge the data file from the test sensor with the data file from the barometric reference sensor. The procedure for doing this follows:

1. Press the browse button next to the **Collected Data File** field to browse to the data files retrieved from the CRS45X.

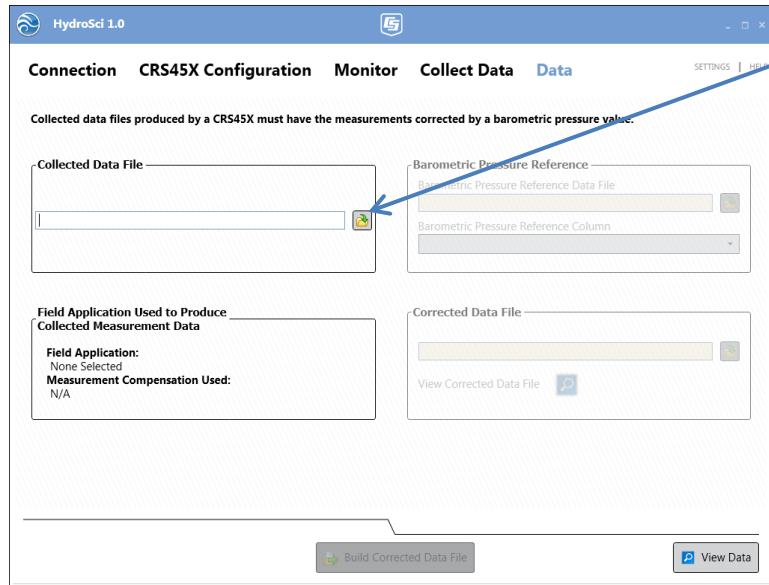

2. Select a data file you wish to be corrected by barometric pressure values.
 - a) The **Field Application Used to Produce Collected Measurement Data** information will be shown based on the collected data file selected.

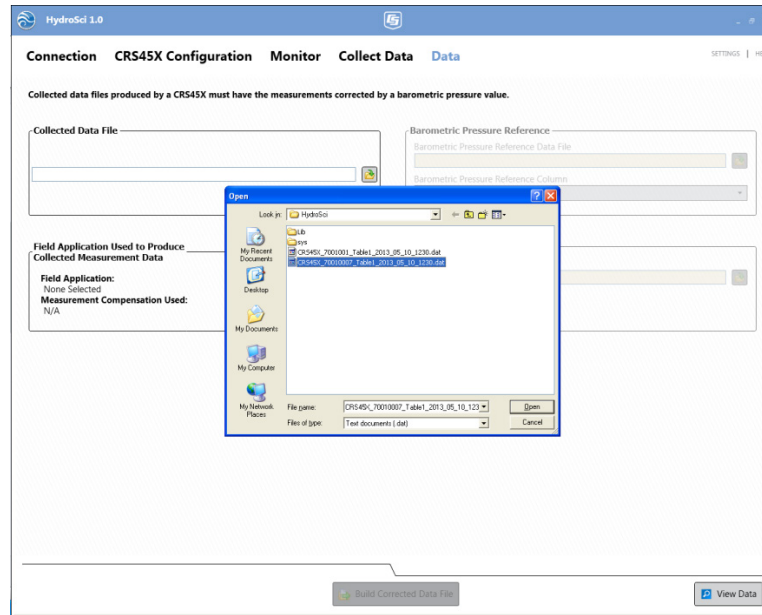

3. Press the browse button next to the **Barometric Pressure Reference Data File** field to browse the data files from the barometric reference sensor.

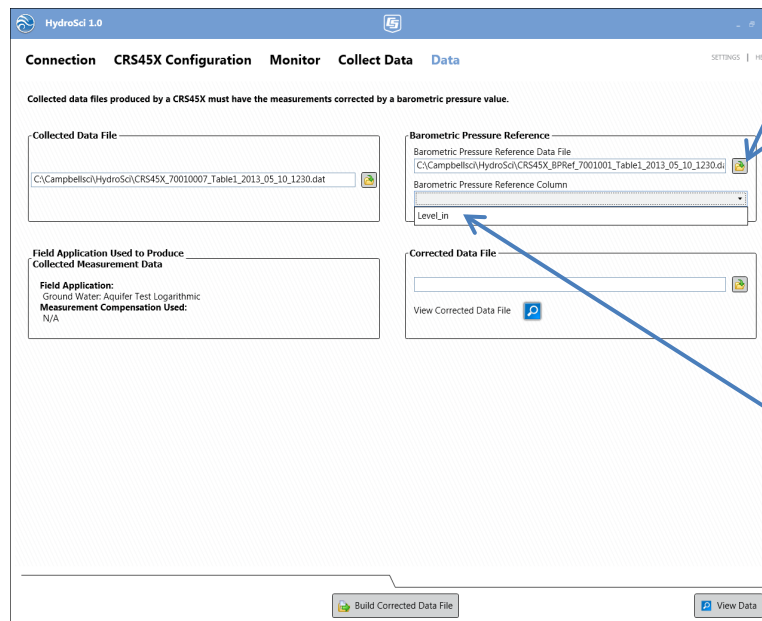

4. Select a data file you wish to use as the barometric pressure reference data file.
 - a) Use the drop-down list to select the **Barometric Pressure Reference Column** in the data file.

The reference column must be a measurement of pressure or level. If from a nearby Campbell Scientific weather station, note that the reference column must have units associated with it. The units can be any pressure or level units as defined in *HydroSci* and they must match exactly the *HydroSci* abbreviation as shown here.

The following pressure and level units are defined in *HydroSci*:

<i>HydroSci</i> Abbreviation	Units of Measure
mm	millimeter
m	meter
ft	feet
in	inch
mb	millibar
bar	bar
kPa	kilopascal
psia	psi absolute

- Press the browse button next to the **Corrected Data File** field to indicate where the corrected data file should be stored.
Rename the file as applicable.
- After completing all of the fields, press the **Build Corrected Data File** button.

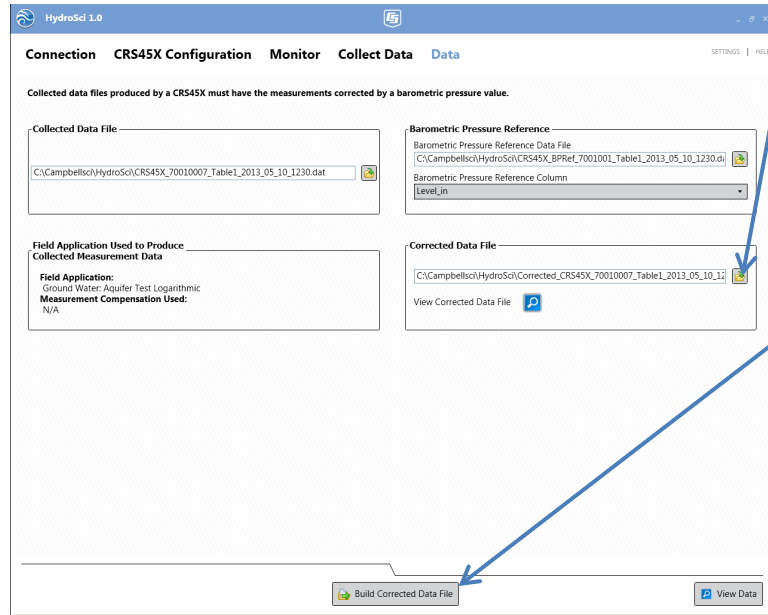

- Once the corrected data file has been built, press the **View Corrected Data File** button to open the file in View.

The **View Data** button at the bottom of the screen can also be used to open View.

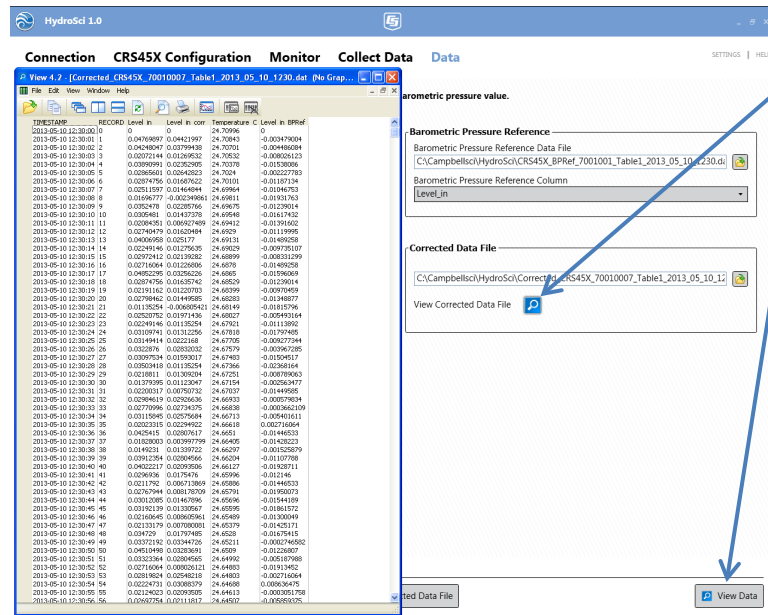

In **View**, use the **File | Open** menu item to browse to any data file you would like to view.

To select the data values to be graphed, click on the column heading(s) in the data file with a single mouse click. The selection will be highlighted and will automatically be added to the graph.

Multiple columns can be added by holding the Ctrl key and dragging the mouse pointer over the column headings.

TIMESTAMP	RECORD	Level_FT	Level_FT_comp	Level_FT_Avg	Level_FT_Avg_comp	Level_FT_BPRef
2013-01-10 10:40:00	0	4.004486	4.004486	4.002243	4.002243	28.42496
2013-01-10 10:45:00	1	3.99704	3.99704	3.997009	3.997009	28.42496
2013-01-10 10:50:00	2	3.99954	3.99954	3.998496	3.998496	28.42496
2013-01-10 10:55:00	3	4.002518	3.997477	4.000861	3.99582	28.43
2013-01-10 11:00:00	4	4.00423	3.999189	4.003804	3.998763	28.43
2013-01-10 11:05:00	5	4.007265	4.002224	4.004518	3.999477	28.43
2013-01-10 11:10:00	6	4.010798	4.008797	4.008736	4.006735	28.42696
2013-01-10 11:15:00	7	4.00869	4.006689	4.009731	4.00773	28.42696
2013-01-10 11:20:00	8	4.005127	4.003126	4.00419	4.002189	28.42696
2013-01-10 11:25:00	9	4.007504	3.996253	4.005643	3.994391	28.43621
2013-01-10 11:30:00	10	4.005165	3.993914	4.005641	3.99439	28.43621
2013-01-10 11:35:00	11	4.009363	3.998112	4.006653	3.995401	28.43621
2013-01-10 11:40:00	12	4.012896	3.993744	4.010926	3.991774	28.44411
2013-01-10 11:45:00	13	4.014696	3.995544	4.014693	3.995541	28.44411
2013-01-10 11:50:00	14	4.019115	3.999963	4.016184	3.997032	28.44411
2013-01-10 11:55:00	15	4.021477	4.000216	4.020328	3.999067	28.44622
2013-01-10 12:00:00	16	4.017925	3.996664	4.019042	3.997781	28.44622
2013-01-10 12:05:00	17	4.022793	4.001532	4.021443	4.000182	28.44622
2013-01-10 12:10:00	18	4.019236	4.005555	4.020504	4.006823	28.43864
2013-01-10 12:15:00	19	4.015192	4.001511	4.015094	4.001412	28.43864
2013-01-10 12:20:00	20	4.014509	4.000828	4.013865	4.000184	28.43864
2013-01-10 12:25:00	21	4.005993	4.001673	4.009868	4.005548	28.43298
2013-01-10 12:30:00	22	4.006227	4.001907	4.00607	4.00175	28.43298
2013-01-10 12:35:00	23	4.003954	3.999634	4.005307	4.000887	28.43298
2013-01-10 12:40:00	24	4.004349	4.009509	4.002311	4.007471	28.41198
2013-01-10 12:45:00	25	3.99637	4.00153	3.998844	4.004004	28.41198

To see the graph, press the **Graph** button. The graph will then appear on a new screen.

An example of the measured data and the barometric pressure compensated data is shown here.

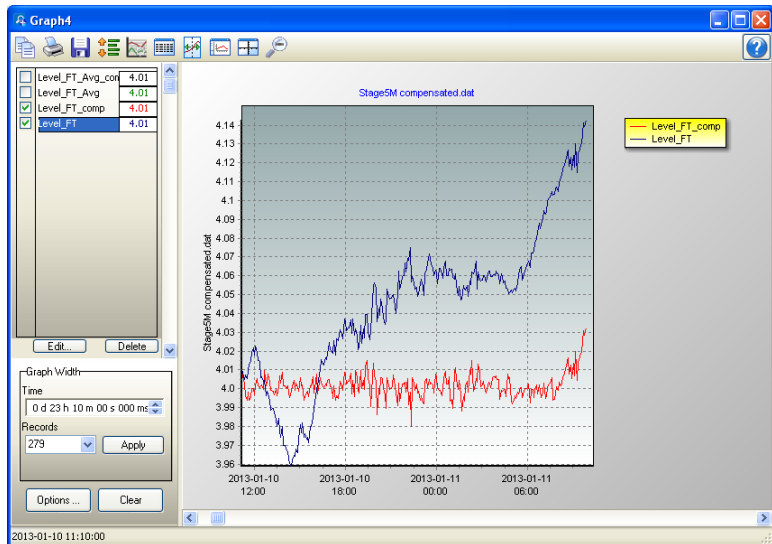

The original data are shown in blue and the compensated data are shown in red.

The barometric pressure sensor data are shown below, also in blue.

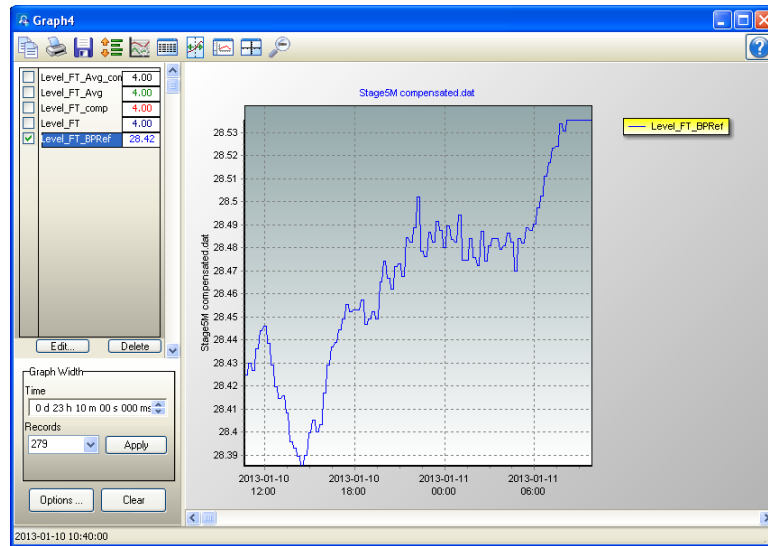

8. Maintenance

Campbell Scientific recommends that the CRS451/CRS456 be factory recalibrated every 24 months. Before a CRS451/CRS456 is sent to Campbell Scientific, the customer must get an RMA (returned material authorization) number and fill out the Declaration of Hazardous Material and Decontamination form.

8.1 Every Visit

- Collect data.
- Visually inspect the physical conditions.
- Check battery condition by using a laptop and *HydroSci* software to view the battery voltage (see Section 6.6, *Battery Voltage Reading (p. 6)*). The battery replacement procedure is provided in Section 8.3, *Battery Replacement (p. 23)*.
- Check all readings; adjust offsets if necessary.
- Check recent data.

8.2 Every Two to Three Years or on a Rotating Schedule

- Send the CRS451/CRS456 in for inspection and calibration.

8.3 Battery Replacement

Remove the set screws on the cap end of the CRS451.

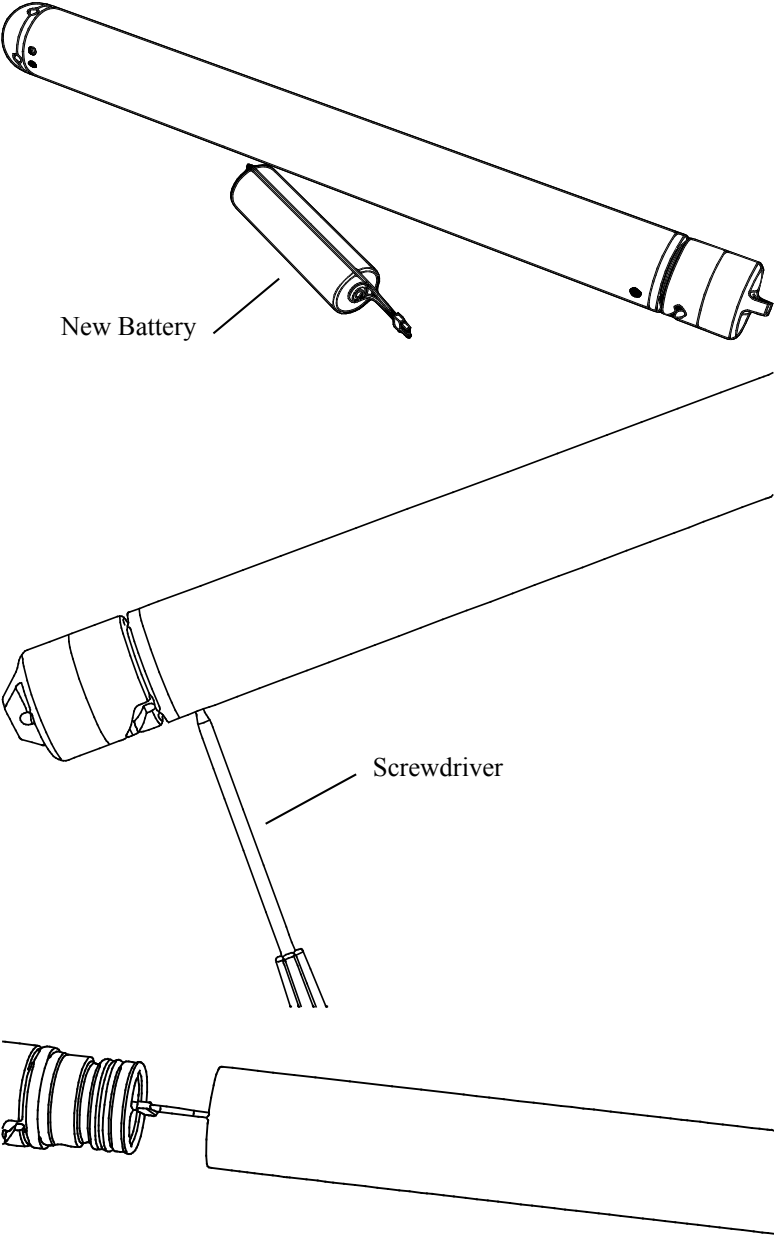

Gently pull the end out of the housing.

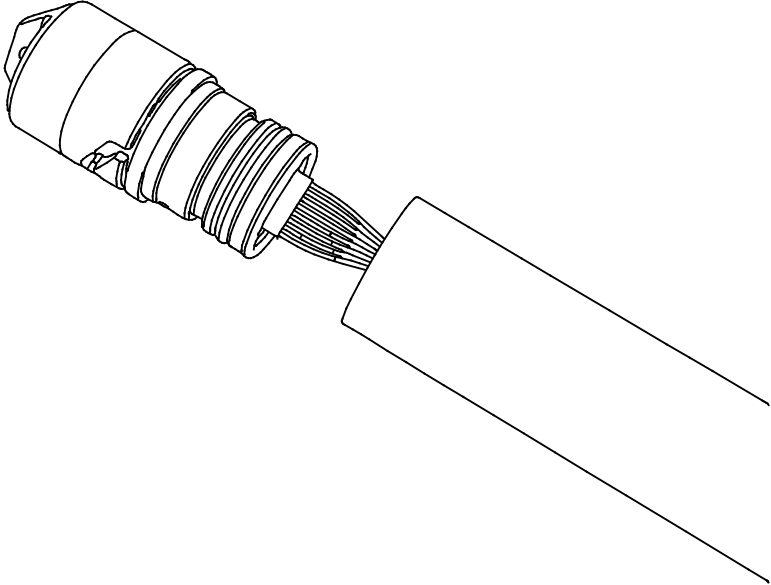

Unplug the connector.

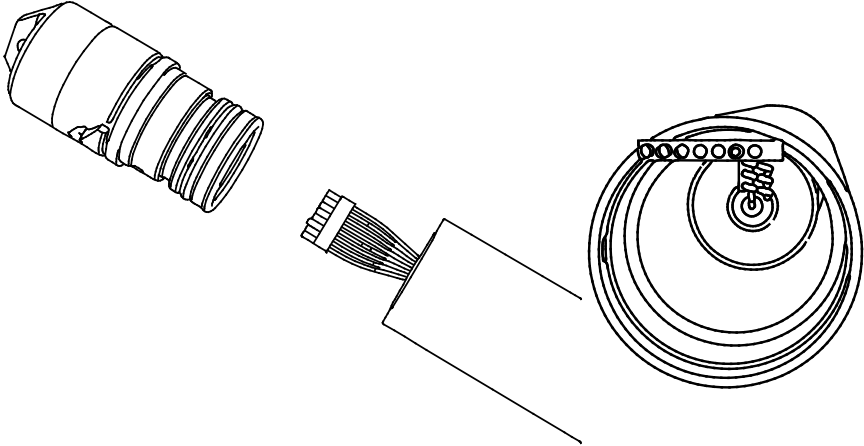

Gently pull the battery out the end.

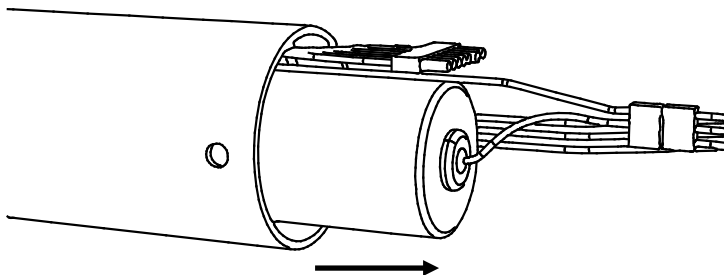

Disconnect the battery.

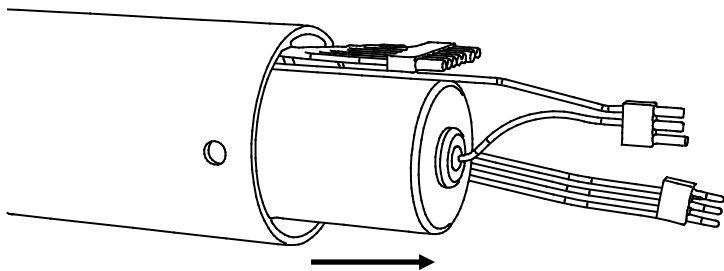

Remove the battery.

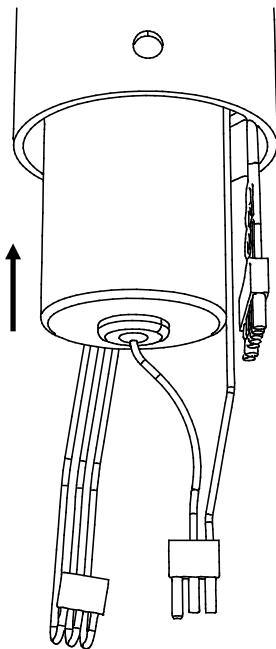

Slide in the new battery.

Plug in the new battery.

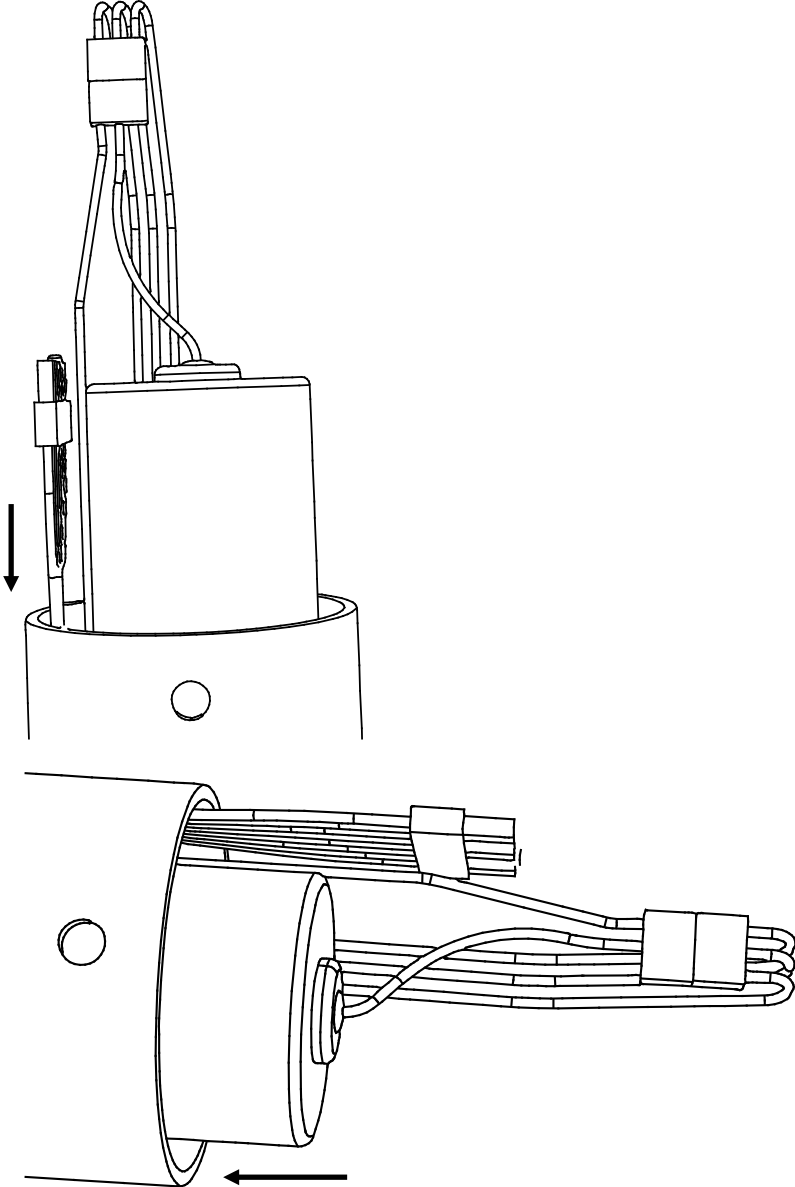

Slide the battery into the housing.

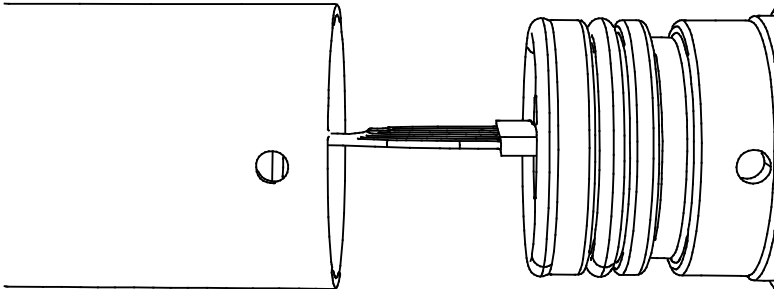

Reconnect the cable.

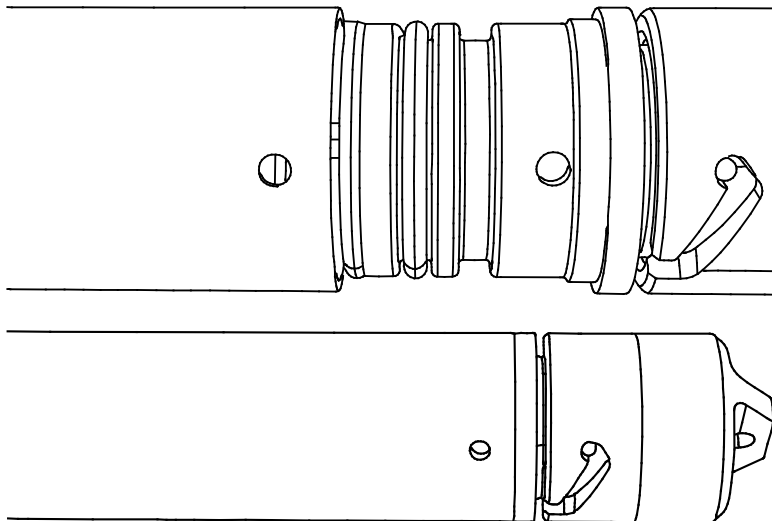

Gently slide the end piece with its O-rings into the housing.

NOTE

Nicking the O-ring could result in a leak.

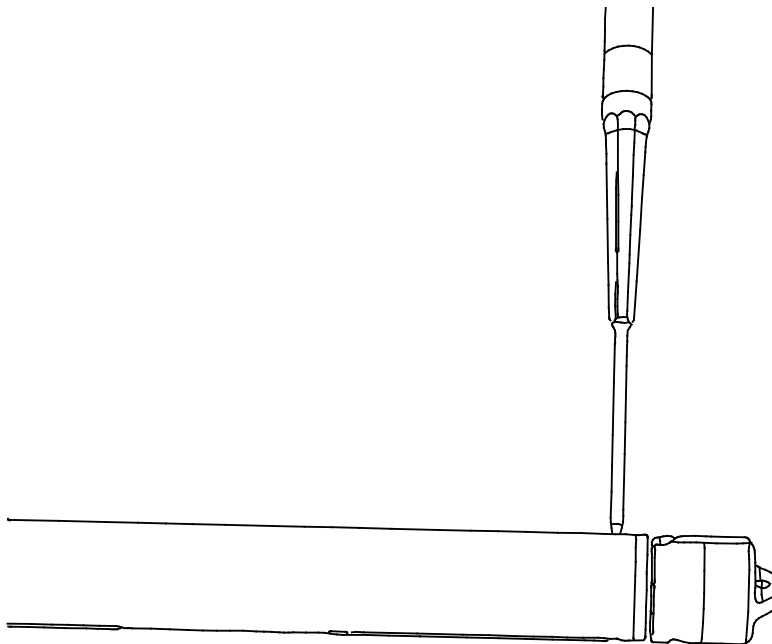

Line up the holes and insert the set screw. Do not over tighten the set screw.

9. Troubleshooting

The most common causes for erroneous pressure transducer data include:

- Low battery
- Damaged CRS451/CRS456
 - Water damage
 - Damage to diaphragm due to excessive pressure
- Atmospheric pressure not subtracted from pressure reading

Problem:

Unit will not respond when attempting USB communications.

Suggestion:

Replace battery.

Correct COM Port used for communication not selected in *HydroSci*.

Appendix A. Calibration Certificate

Each CRS451/CRS456 has been calibrated to meet printed accuracy specification at multiple temperature and pressure ranges. If additional verification is required, a Calibration Certificate can be purchased for each CRS451/CRS456 Water-Level Recording Sensor.

The Instrument Data Report provides a list of the pressure and temperature at which the sensor was tested.

Pressure [kPa] is the pressure applied (listed in kilopascals) to the sensor. **Temperature [°C]** is the temperature inside the test chamber at the time of testing. **Pressure After [kPa]** represents the resulting measurement output by the CRS451/CRS456 at the given pressure and temperature. Finally, **Deviation After [%F.S.]** provides the difference between the actual pressure applied to the sensor and the pressure measurement output by the sensor. This value is listed as a percentage of the full scale range of the sensor.

When a CRS451/CRS456 is returned to Campbell Scientific for calibration, the sensor will be returned with an Instrument Data Report. This report will include values in the **Pressure Before [kPa]** column. These values represent the measured pressure the sensor returns at the specified pressure and temperature, BEFORE calibration.

Appendix B. Conversion to Units of Measurement

TABLE B-1. Conversion Factors	
Unit of Measurement	Factor of Conversion
Feet	2.3066587369
Inches	27.679904843
Meters	0.1019716213
Millimeters	101.9716213

Campbell Scientific Companies

Campbell Scientific, Inc.

815 West 1800 North
Logan, Utah 84321
UNITED STATES

www.campbellsci.com • info@campbellsci.com

Campbell Scientific Canada Corp.

14532 – 131 Avenue NW
Edmonton AB T5L 4X4
CANADA

www.campbellsci.ca • dataloggers@campbellsci.ca

Campbell Scientific Africa Pty. Ltd.

PO Box 2450
Somerset West 7129
SOUTH AFRICA

www.campbellsci.co.za • cleroux@csafrica.co.za

Campbell Scientific Centro Caribe S.A.

300 N Cementerio, Edificio Breller
Santo Domingo, Heredia 40305
COSTA RICA

www.campbellsci.cc • info@campbellsci.cc

Campbell Scientific Southeast Asia Co., Ltd.

877/22 Nirvana@Work, Rama 9 Road
Suan Luang Subdistrict, Suan Luang District
Bangkok 10250
THAILAND

www.campbellsci.asia • info@campbellsci.asia

Campbell Scientific Ltd.

Campbell Park
80 Hathern Road
Shepshed, Loughborough LE12 9GX
UNITED KINGDOM

www.campbellsci.co.uk • sales@campbellsci.co.uk

Campbell Scientific Australia Pty. Ltd.

PO Box 8108
Garbutt Post Shop QLD 4814
AUSTRALIA

www.campbellsci.com.au • info@campbellsci.com.au

Campbell Scientific Ltd.

3 Avenue de la Division Leclerc
92160 ANTONY
FRANCE

www.campbellsci.fr • info@campbellsci.fr

Campbell Scientific (Beijing) Co., Ltd.

8B16, Floor 8 Tower B, Hanwei Plaza
7 Guanghua Road
Chaoyang, Beijing 100004
P.R. CHINA

www.campbellsci.com • info@campbellsci.com.cn

Campbell Scientific Ltd.

Fahrenheitstraße 13
28359 Bremen
GERMANY

www.campbellsci.de • info@campbellsci.de

Campbell Scientific do Brasil Ltda.

Rua Apinagés, nbr. 2018 – Perdizes
CEP: 01258-00 – São Paulo – SP
BRASIL

www.campbellsci.com.br • vendas@campbellsci.com.br

Campbell Scientific Spain, S. L.

Avda. Pompeu Fabra 7-9, local 1
08024 Barcelona
SPAIN

www.campbellsci.es • info@campbellsci.es

Please visit www.campbellsci.com to obtain contact information for your local US or international representative.